



PVCU
COLLECTION

everglade
windows

PVCu Collection

'to be the best in all we do'	4
over 35 years of manufacturing	5
kitemark accredited survey & installation	6
10 year peace of mind guarantee	7
casement windows	8-11
traditional finishing touches	12-13
doors	14-17
premiline pro patio door	18-21
everguard hinge protection	22-23

'To be the best in all we do!'

At Everglade Windows, we are devoted to progressive thinking and pushing boundaries. We have adapted to the challenges that have presented themselves over the last 35 years and, with a rigorous attitude, have built legendary windows and doors.

Our culture is one of being inclusive, embracing diversity, to be part of the family, and to create a sense of belonging - not only with our staff and customers, but with our partners and suppliers. We give customers certainty and a level of service that creates a unique sense of affinity for what we stand for.



Over 35 Years of Manufacturing

Every product we manufacture is made with care and expert precision in our two manufacturing facilities in West London.

We have been awarded BS EN ISO 9001:2008 for the manufacture of UPVC and aluminium windows and doors.

Everglade practices lean manufacturing enabling us to improve efficiency and reduce waste. Our production facility offers an impressive balance of automation backed by the human touch - a workforce of fully trained specialists.

Manufacturing automation is backed by years of product knowledge. Our skilled craftsmen, Installation team and Support team collectively have formal qualifications in Customer Service, Lean Techniques, Window Installation and Window Manufacturing.

Kitemark Accredited Survey & Installation

As a Kitemark Installer, Everglade has a wealth of installation and survey expertise. Installations are carried out by our own fully trained teams. Everglade is one of the few companies to invest in training and each fitter must attend regular programmes in our own purpose built training workshop. After all, the quality of your new windows and doors is only as good as the fitters who install them. We are accredited by BSI Kitemark and FENSA to ensure our windows are fitted to a high standard.

We are also QMS accredited for the Manufacture of UPVC and aluminium, windows and doors. This International Standard promotes the adoption of a process approach when developing, implementing and improving the effectiveness of a quality management system, to enhance customer satisfaction by meeting customer requirements.



10 Year Peace of Mind Guarantee

Our windows and doors are equipped with a multi-point locking system, shootbolt security locks and hinge clasp are all as standard. No wonder why our UPVC windows & doors are Secured by Design (Police preferred specification). By opting for Everglade, you are making your house safer than ever.

Installations carried out by Everglade include a comprehensive ten year guarantee. As a company established over 35 years with thousands of satisfied customers, you can have complete peace of mind when choosing Everglade.



Casement Windows

The Kömmerling system offers a unique combination of classic appearance and state-of-the-art performance. It's also extruded using lead-free PVCu Greenline compound. The O70 system, with its revolutionary ovolo profile, has been designed to enhance any home, offering a unique combination of classic appearance and state-of-the-art performance. The curved slimline frames and opening sashes create a 'softer' appearance adding a little design flair to any installation in the home.

The C70 chamfered system is a 5-chambered modern system. This system benefits from the cleaner lines of a modern chamfered suite of profiles for the design conscious.

C70 and O70 systems can be complemented with a front/rear door, patio door or a conservatory.

Both C70 and O70 are extruded using lead-free PVCu Greenline compound - enabling complete exclusion of heavy metals from the entire production processes.

- 1 70mm frame depth
- 2 5 chambered profile for better thermal performance
- 3 Energy efficient WER bar reinforcement
- 4 Slim sightlines with a lowline grey gasket and option of black gasket
- 5 Chamfered or ovolo glazing beads
- 6 Wide range of colours - 44 woodgrain and coloured finishes
- 7 Internal beading for enhanced security
- 8 High impact, colourfast and environmentally friendly lead-free PVCu profiles that will not discolour
- 9 Suitable for double or triple glazing
- 10 Features high security multipoint lock and Everguard Hinge protection. Secured by Design upgrade available

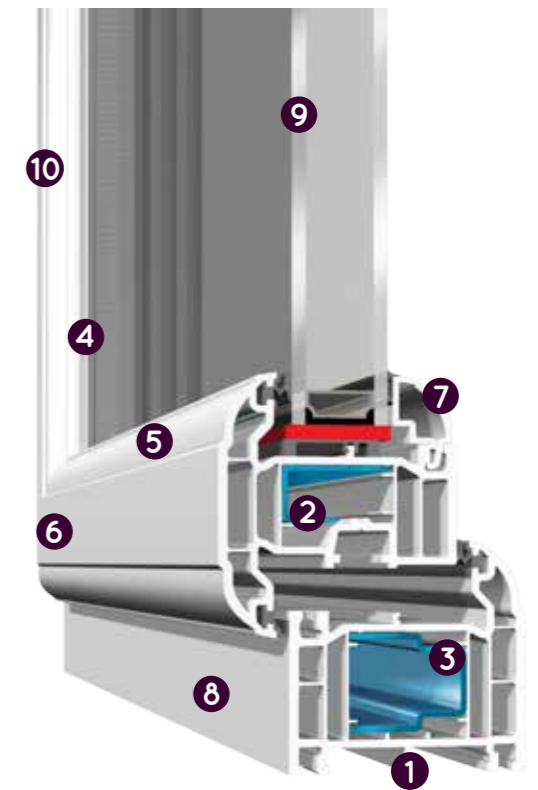



COLOURS



White Rosewood Golden Oak Cream Black/Brown White Foil Anthracite Grey Irish Oak

HANDLES

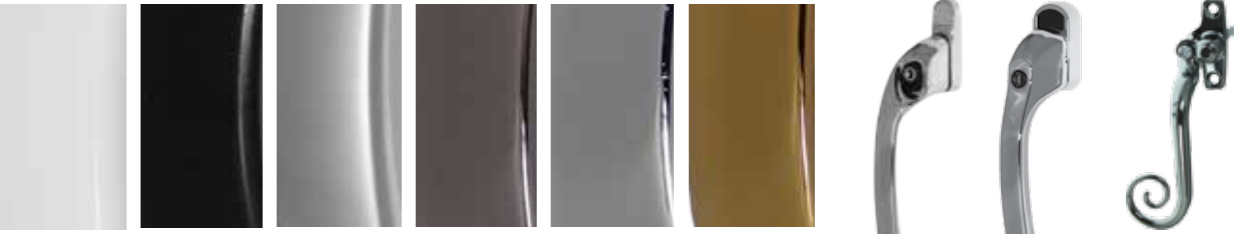

White Black Silver Smokey Chrome Polished Chrome Gold
 Espag Tilt & turn Monkey Tail (Black, Gold and Polished Chrome only)

SECURITY



High security multipoint shootbolt lock Everguard hinge protection system Durable stainless steel easy glide hinge.



PAS 24 Compliant SBD upgrade available

GLAZING

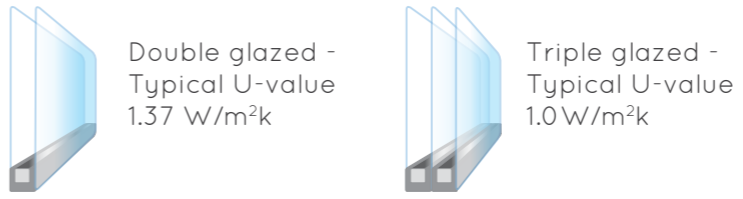

Double glazed - Typical U-value 1.37 W/m²k Triple glazed - Typical U-value 1.0 W/m²k

STYLES

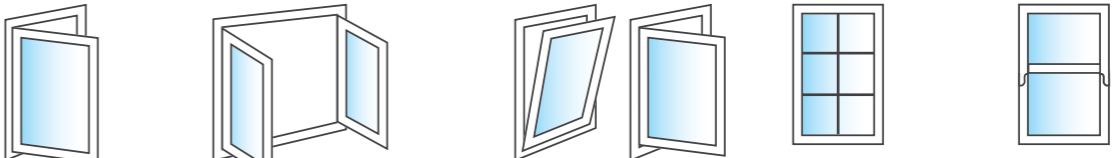

Casement French Casement Tilt & Turn Astragal Bars Run Through Sash Horns

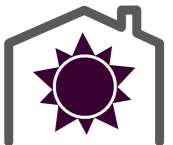

A-C energy rating U-values up to 1.0 W/m²k



Watertight to 60kg per square metre (600pa)

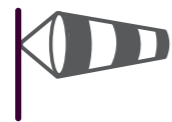

Resistant to wind loads of over 120mph (2000pa)



Secured by Design Upgrade available



5 chamber lead free system

Traditional Finishing Touches

Enjoy traditional looking windows without compromising on security and energy efficiency. Astragal bars are available in a range of colours and can be chamfered or featured. Duplex sealed units creates an authentic period look.

Run through sash horns are mechanically jointed to create an authentic look and feature a unique one piece end cap for a smart finish.

The Kömmerling system offers a unique combination of classic appearance and state-of-the-art performance. It's also extruded using lead-free PVCu Greenline compound.



Astragal Bars

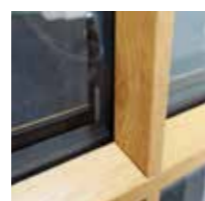

Duplex sealed unit creates authentic period look



Mitred joints create a hand finished appearance

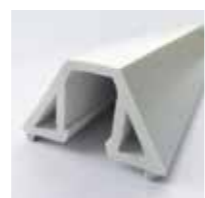

Chamfered Bar - Available in White, Cream, Golden Oak, Rosewood, Black/brown

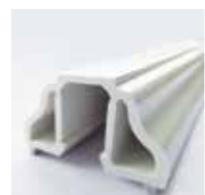

Featured Bar - Available in White, Cream, Golden Oak, Rosewood, Black/brown, Irish Oak and Chartwell Green

Run Through Sash Horns



Run through machine profiled sash horn



Mechanically jointed bottom rail for authentic look



Unique one piece end cap for a smart finish

Doors

The Kömmerling system offers a unique combination of classic appearance and state-of-the-art performance. It's also extruded using lead-free PVCu Greenline compound. The O70 system, with its revolutionary ovolo profile, has been designed to enhance any home, offering a unique combination of classic appearance and state-of-the-art performance. The curved slimline frames and opening sashes create a 'softer' appearance adding a little design flair to any installation in the home.

The C70 chamfered system is a 5-chambered modern system. This system benefits from the cleaner lines of a modern chamfered suite of profiles for the design conscious.

C70 and O70 systems can be complemented with a front/rear door, patio door or a conservatory.

Both C70 and O70 are extruded using lead-free PVCu Greenline compound - enabling complete exclusion of heavy metals from the entire production processes.

- 1 70mm frame depth
- 2 5 chambered profile for better thermal performance
- 3 Energy efficient WER bar reinforcement
- 4 Slim sightlines with a lowline grey gasket and option of black gasket
- 5 Chamfered or ovolo glazing beads
- 6 Wide range of colours - 44 woodgrain and coloured finishes
- 7 Internal beading for enhanced security
- 8 High impact, colourfast and environmentally friendly lead-free PVCu profiles that will not discolour
- 9 Suitable for double or triple glazing
- 10 Features high security multipoint lock and Everguard Hinge protection. Secured by Design upgrade available
- 11 Document M compliant low threshold option available

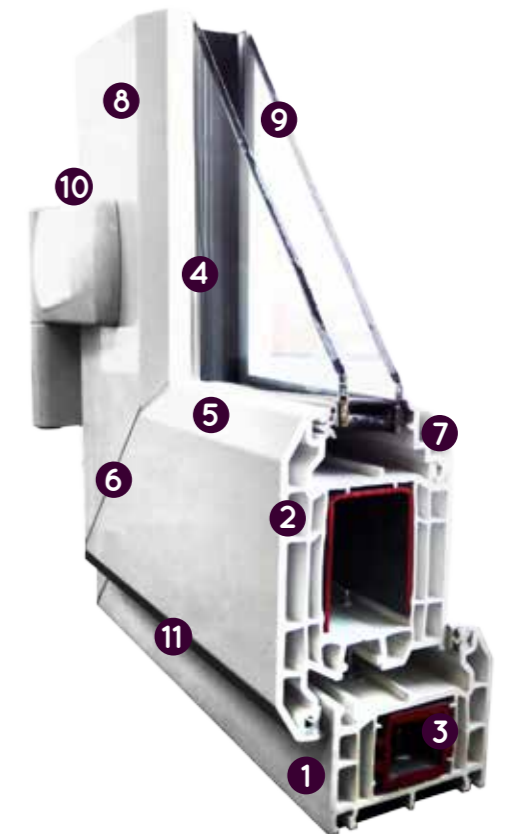



COLOURS



HANDLES



SECURITY



PAS 24 Compliant SBD upgrade available

GLAZING OPTIONS

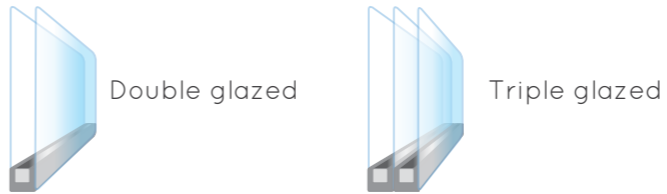

STYLES

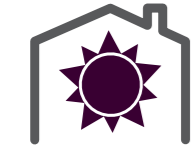

U-values up to 1.8 W/m²k



Watertight to 30kg per square metre (300pa)

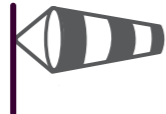

Resistant to wind loads of over 80mph (800pa)



Secured by Design Upgrade available



5 chamber lead free system

Premiline PRO PVCu Patio Door

The patented Premiline PRO is one of the UK's first PAS 24 certified PVCu patio doors that doesn't require unsightly plunge bolts, carries Secured by Design and importantly meets the requirements for Lifetime Homes.

An intuitive and clever locking system is hidden at the interlock and only requires the turn of a door handle to fully engage the enhanced security locking mechanism. It's one of the first PVCu patio door systems to meet the Lifetime Homes Standard.

Smooth operation, durable and eco friendly, Kömmerling Premiline incorporates all the benefits of uPVC with modern design. Stainless steel tracks ensure that your doors slide smoothly and effortlessly, and are also durable and secure. Frames are fully reinforced for added strength, and as well as being internally glazed, advanced multipoint locking makes this door fully secure.

Premiline patio doors fully complement the C70 range of windows and doors.

- 1 The only PVCu patio door that carries Secured by Design without the use of unsightly plunge bolts and meets the Lifetimes Homes standard
- 2 Meets new Document Q of the Building Regulations
- 3 Ingenious, patent protected design with hidden locking mechanism which eliminates the need for unsightly plunge bolts
- 4 Perfect for all market sectors where added security is crucial
- 5 Option of three different handle finishes: chrome, white and black
- 6 Striking design with a choice of low level gaskets in grey or black
- 7 Outer frames can be welded or mechanically jointed (not shown)
- 8 Low threshold option also available (not shown)

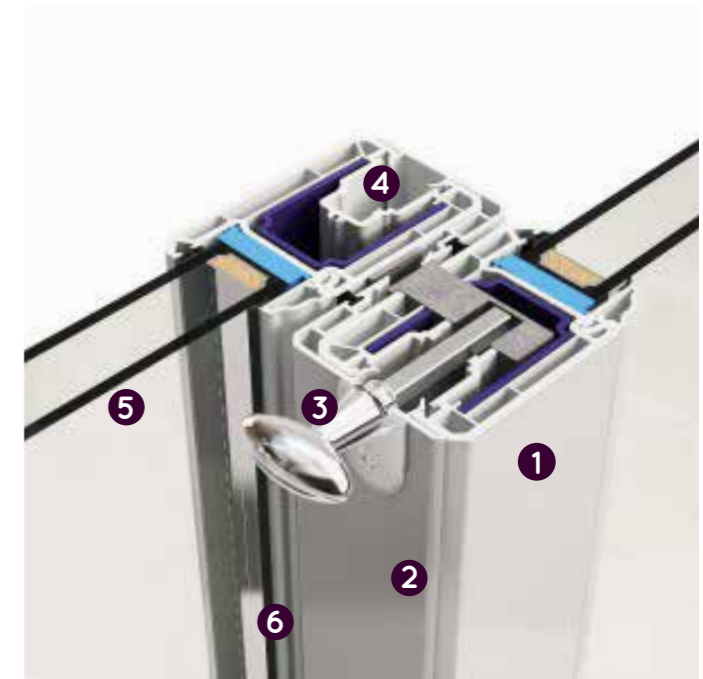



Smooth operation, durable and eco friendly, Kömmerling Premiline incorporates all the benefits of uPVC with modern design. Stainless steel tracks ensure that your doors slide smoothly and effortlessly, and are also durable and secure. Frames are fully reinforced for added strength, and as well as being internally glazed, advanced multipoint locking makes this door fully secure.

Available in 2, 3 or 4 pane options, the sliding door can be installed to either the inside or outside track ensuring greater flexibility. In situations where there is limited access, outer frames can be mechanically jointed on site. Premiline patio doors fully complement the C70 range of windows and doors.



Lifetime Homes Compliant



U-value 1.8 W/m²k



Airtight to 30kg per square metre (300pa)

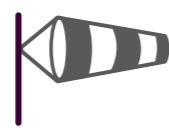

Resistant to wind loads of over 120mph (1800pa)



Secured by Design



5 chamber lead free system

COLOURS



White Rosewood Golden Oak Cream Black/Brown White Foil Anthracite Grey Irish Oak

HANDLES



White Black Silver D Handle

SECURITY



High security Interlock shootbolt lock

Secured by Design



Official Police Security Initiative

SBD upgrade available

GLAZING OPTIONS



Double glazed



Triple glazed

STYLES

2 Pane

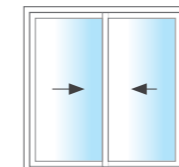
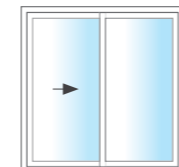

3 Pane

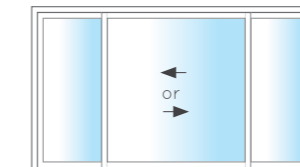

4 Pane

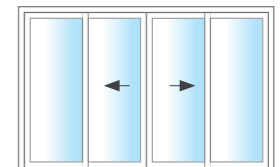

Everguard Hinge Protection

Everguard hinge protection for windows and doors has been through extensive testing and is above entry level for window hinge protection. A load pressure of 4KN for 10 seconds merits a pass. Everguard was tested to destruction and withstood an impressive 7.5Kn. That's the equivalent force of an F1 Car, Driver and full tank of fuel pushing down on an area of just 25mm²

Watch the full testing video at www.youtube.com/evergladewindowsltd



High security multi-point locking as standard

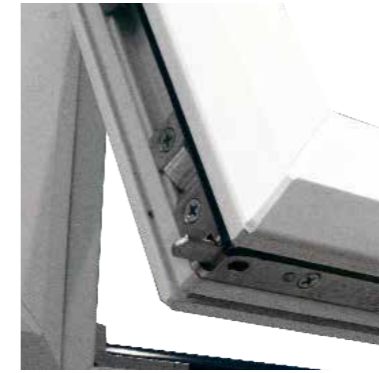

High security multipoint shootbolt lock. When activated, shootbolts engage firmly into keeps fitted to the window frame to add extra security.



Handle operated shootbolts to slave and master door on French door styles



anti snap and bump cylinder



Internally beaded to prevent glass being removed from the outside



PAS 24:2012

PAS 24 Enhanced security performance requirements for doorsets and windows in the UK.

Secured by Design



Our SBD window option meets the performance specifications of the rigorous Secured by Design standard



locking window handles

design your windows at
www.everglade.co.uk

everglade
windows

020 8998 8775
www.everglade.co.uk

visit our showroom:
22 Wadsworth Road
Perivale, Greenford
Middx UB6 7JD

connect with us:

